

User Manual



Questions? Need Some Help?

This manual should help you understand your new product.

If you still have questions,
visit our website:
www.iontheaction.com

Link Us:
www.facebook.com/iontheaction

Tweet Us:
www.twitter.com/iontheaction



FCC STATEMENT

This device complies with Part 15 of the FCC Rules. ☐ Operation is subject to the following two conditions: ☐

- (1) This device may not cause harmful interference. ☐
- (2) This device must accept any interference received, including interference that may cause undesired operation.

Note:

This equipment has been tested and found to comply with the limits for Class B digital devices, pursuant to Part 15 of the FCC rules. These limits are designed to provide reasonable protection against harmful interference in a residential installation. This equipment generates uses and can radiate radio frequency energy and, if not installed and used in accordance with the instructions, may cause harmful interference to radio communications. However, there is no guarantee that interference will not occur in a particular installation. If this equipment does cause harmful interference to radio or television reception, which can be determined by turning the equipment off and on, the user is encouraged to try to correct the interference by one or more of the following measures:

- !! Reorient or relocate the receiving antenna. ☐
 - !! Increase the separation between the equipment and receiver. ☐
 - !! Connect the equipment into an outlet on a circuit different from that to which the receiver is connected.
 - !! Consult the dealer or an experienced radio/TV technician for help.
- Use of shielded cable is required to comply with Class B limits in Subpart B of Part 15 of the FCC rules.

Do not make any changes or modifications to the equipment unless otherwise specified in the manual. ☐ If such changes or modifications should be made, you could be required to stop operation of the equipment.

Notice:

If static electricity or electromagnetism causes data transfer to discontinue midway (fail), restart the application or disconnect and connect the communication cable (USB, etc.) again.



This product contains electrical or electronic materials. The presence of these materials may, if not disposed of properly, have potential adverse effects on the environment and human health. Presence of  this label on the product means it should not be disposed of as unsorted waste and must be collected separately. As a consumer, you are responsible for ensuring that this product is disposed of properly.

To find out how to properly dispose of this product, please go to www.iontheaction.com and click on "Support" or call the customer service number for your country listed in the instruction manual.



READ THIS FIRST

Trademark Information

- !! © 2012 World Wide Licenses Limited.
- !! ® The ion logo is a registered trademark of World Wide Licenses Limited.
- !! CamLOCK, PODZ, Shoot/Share and AIR PRO and their respective logos are trademarks or registered trademarks of World Wide Licenses Limited in the United States and other countries. Copyright © 2012. All Rights Reserved.
- !! Microsoft® and Windows® are U.S. registered trademarks of Microsoft Corporation.
- !! Pentium® is a registered trademark of Intel Corporation.
- !! iPhone, iPad, Macintosh is a trademark of Apple Inc.
- !! MicroSD™ is a trademark.
- !! Other names and products may be trademarks or registered trademarks of their respective owners.

Product Information

- !! Product design and specifications are subject to change without notice. This includes primary product specifications, software, and user's manual. This User Manual is a general reference guide for the product.
- !! The product and accessories that come with your ion camera may be different from those described in this manual. This is due to the fact that different retailers often specify slightly different product inclusions and accessories to suit their market requirements, customer demographics, and geographical preferences. Products very often vary between retailers especially with accessories such as chargers, memory cards, cables, pouches, mounting accessories and language support. Occasionally a retailer will specify a unique product color and appearance. Contact your dealer for precise product definition and included accessories.
- !! The illustrations in this manual are for the purpose of explanation and may differ from the actual design of your ion camera.
- !! The manufacturer assumes no liability for any errors or discrepancies in this user manual.

SAFETY INSTRUCTIONS

Read and understand all **Warnings** and **Cautions** before using this product.

Warnings:

Make sure the PODZ is completely sealed before use. If foreign objects or water have entered the camera, turn the power off.

Continued use may cause an injury. Please call our friendly customer service for assistance.

If the camera has been dropped or its case has been damaged, turn the power off.

Continued use may cause an injury. Please call our friendly customer service for assistance.

There are no user serviceable parts for the camera: DO NOT DISSASSEMBLE!

For repair, please call our friendly customer service for assistance.

Do not place the camera on unstable surfaces.

This may cause the camera to fall or tilt over, causing damage.



Cautions:

A camera is a precision instrument. Do not drop, strike, or use excessive force when handling the camera.

This may cause damage to the camera.

Do not use the camera in humid, steamy, smoky, or dusty places.

This may cause fire or electric shock.

Do not leave the camera in places where the temperature may rise significantly such as inside a car.

This may adversely affect the case or the parts inside.

Before you move the camera, disconnect cords and cables.

Failure to do this may damage cords and cables.

This is an extreme sports video product.

Please be careful of the controlled use of the product not to fall on the camera to cause bodily injury

CONTENT

INTRODUCTION	8
Overview.....	8
Package Contents.....	9
GETTING TO KNOW YOUR CAMERA	10
GETTING STARTED	11
Charging The Battery.....	11
Inserting MicroSD Card.....	12
Setting Up Date & Time.....	13
Closing The Camera PODZ.....	14
Power On & Power Off.....	15
Recording Videos.....	16
Taking Photos.....	17
Reset The Camera.....	18
Using PODZ.....	18
Using CamLOCK Mount System.....	18
Auto Rotation.....	19
CONNECTING CAMERA TO A COMPUTER	20
Running the ion Software.....	20
Browsing The Files & Transferring Them To A PC.....	20
Changing The Camera Settings.....	21
Linking To ion Websites And Cloud Service.....	24
Firmware Update & Installation.....	24
CONNECTING CAMERA TO A TV / HDTV	26
Taking Photos w/ TV.....	27
Recording Video w/ TV.....	28
Playing Back Photo Files w/ TV.....	28
Playing Back Video Files w/ TV.....	29
Change TV Language.....	30
Deleting Photos / Video Files w/ TV.....	30
Formatting MicroSD Card w/ TV.....	31
SIGN UP FOR FREE ION CLOUD STORAGE	32
SPECIFICATION	33
SYSTEM REQUIREMENTS	34
TROUBLESHOOTINGS	35



INTRODUCTION

Overview

Thanks for purchasing the ion AIR PRO camera. **The ion AIR PRO can be mounted with the Bike & Helmet Kit or the BOARD Kit for the ultimate adventure HD recording experience.**



HD recording – Up to 1080p resolution



Waterproof to 10m or 30ft



Long battery life approx. 2.5 hrs when fully charged at 720p/30fps



170 degree wide-angle lens



Lighter than 4.6 ounces



Captures high resolution photos



WiFi Ready, PODZ compatible



8GB FREE ion Cloud storage

Package Contents

Carefully unpack the ion AIR PRO and ensure that you have the following items:

	<u>AIR PRO</u>	<u>AIR PRO PLUS</u>	<u>AIR PRO WIFI</u>
AIR PRO	!!	!!	!!
USB Cable and Adapter	!!	!!	!!
AV Cable	!!	!!	!!
Software CD-ROM	!!	!!	!!
Quick User Guide	!!	!!	!!
Pouch	!!	!!	!!
Tripod	!!	!!	!!
Secure Strap	!!	!!	!!
CamLOCK	!!	!!	!!
Helmet & Bike Kit		!!	!!
WIFI PODZ			!!

Common (Optional) Accessories:

!! MicroSD or MicroSDHC card up to 32 GB (Class 6 or higher recommended.)



GETTING TO KNOW YOUR CAMERA

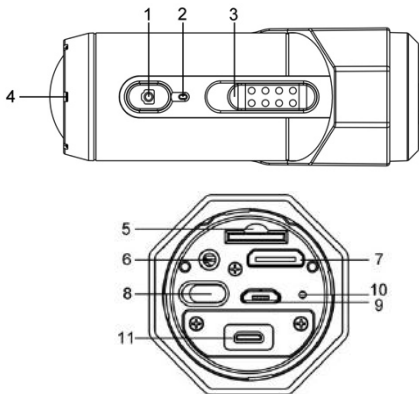

- 1. Power
- 2. LED Indicator
- 3. Recording Slide Switch
- 4. Lens
- 5. MicroSD Card Slot
- 6. AV Port

- 7. HDMI Port
- 8. Video Resolution Switch
- 9. USB Port
- 10. Reset Button
- 11. PODZ Socket

GETTING STARTED

Charging the Battery

The embedded **1200mAh Li-Polymer Battery** in the AIR PRO camera can be recharged quickly allowing you hours of recording time.

To charge the battery

1. Charge the camera with either the USB cable or AC/DC adapter.
2. The Red LED remains ON while the battery is charging.
3. The Red LED will turn OFF when the battery is fully charged. It takes about 3 hours to initially charge the camera. Subsequent charges take approximately 3 hours as well.



- !! When the battery power is low, the camera will vibrate three times to indicate the low battery.
- !! The camera will vibrate 2 seconds to indicate it's out of power. The camera will automatically save the file if it is in recording and turn off.
- !! If the camera does not charge, please contact our help line for assistance as you should not attempt to remove the internal battery. Doing so, will void your warranty coverage and can possibly damage the camera.



Inserting MicroSD Card (not included)

AIR PRO supports a MicroSD card up to 32GB (Class 6 or greater cards are recommended) which allows you to take Full High Definition (FHD) Video for approximately 4 hours (1080p 30 fps or 720p 60 fps). If there is no MicroSD card in the camera, the Red and Green LED will flash alternatively and continuously.

To insert a MicroSD card

Insert a MicroSD card (not included) before using your camera. Assure that the camera power is turned OFF before inserting the card to the slot. The MicroSD card will click into the slot once it is fully inserted.



- !! There is only one correct direction as shown in the illustration to insert the MicroSD card into the slot. Do not force the card into the card slot or it may damage both the camera and the MicroSD card.
- !! A new MicroSD card should be formatted before using. For instructions on how to format the card, please refer to the Section “Connecting the camera to Computer/TV/HDTV”.

Setting Date & Time

You can set the camera's clock with the ion software to ensure that your video and photo files are saved with the correct date/ time information.

To set up the camera clock

1. Connect your camera to a computer with the USB cable. Run ion.exe at your MicroSD card folder.
2. Find the "Date and Time" and click "SET".
3. Adjust the date and time or click " Sync with PC" to set with your PC clock.
4. Click "Ok" to save the settings.

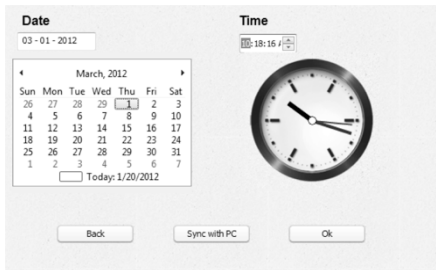

!! User interface may vary with further firmware upgrade.



Closing the Camera PODZ

The **Waterproof Housing** lets the camera perform up to 10 meters or 30 feet under water. You must seal the camera with PODZ in order to protect the camera when using it in wet or moist conditions.

To secure the PODZ

1. Attach the PODZ to the back of the camera and rotate clockwise until two dots are aligned
2. Slide the latch on the PODZ to lock it.

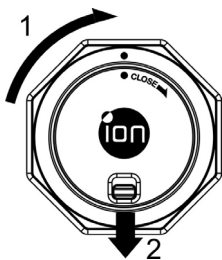

!! Failure to properly seal your camera can result in leaks that damage or destroy your camera. Your warranty does not cover water damage resulting from user damage.

- !! The rubber seal on the PODZ forms the waterproof barrier to protect the camera in wet and underwater conditions. You must keep this seal clean as a single strand of hair or grain of sand can cause a leak into the product.
- !! After every use in salt water, you will need to rinse the outside of the product and the seal with non-salt water and dry. Not doing this can cause corrosion in the product or failure in the seal, in turn, damaging the product.

Power On & Power Off

To power ON the camera:

Press and hold the Power  button. The camera will vibrate and the Green LED will turn on.

To power OFF the camera:



Press and hold the Power  button. The camera will vibrate two seconds and the Green LED will turn off.





Recording Videos

Before you start recording, select the video resolution by switching the **Video Resolution Switch** . There are two HD options to select from: HD (720p 60fps or 720p 30fps) and FHD (Full HD 1080p 30fps or 960p 30fps). You can change the resolution by changing the settings with ion software.

There are two methods available for starting the video record function. When starting a video recording, a short vibration indicates recording started. The LED indicator illuminates RED throughout the recording.

1. Whether the camera power is ON or OFF, simply slide the Recording Slide Switch  from STOP to REC to start recording.
2. When your camera is OFF and the Recording Slide  is at REC location, press and hold the Power  button to turn the camera ON and it will start recording.

Move the Recording Slide Switch  from REC to STOP to stop recording. The camera will vibrate and the LED indicator will illuminate GREEN to indicate the recording has stopped. The camera will then enter Standby mode.

An additional option is to hold the Power  button to stop the recording and turn the camera off. The camera will vibrate two seconds and the Red LED light will turn off.





- !! An additional 432x240 (w/ 1080p/720p) or 320x240 (w/ 960p) video file will be created simultaneously with the recording of an HD/FHD video file. The smaller video file size allows for more efficient uploading of content to social media sites and email.
- !! Changing video resolution is disabled during video recording

- !! There will be around 1-2 second delay before the camera starts recording
- !! The various video resolution options for HD and FHD can be changed under the “Settings” selection in the ion software.
- !! Assure there is sufficient memory available on the MicroSD card. If the card is full, the camera will vibrate for five seconds and the Green LED will flash continuously.

Taking Photos

Ion AIR PRO camera allows you to take **5 Mega Pixels** resolution high quality still images.

To capture a still image

1. Turn on the camera by pressing the Power  button. Move the Recording Slide Switch  to STOP if the camera is in video recording.
2. After the camera power has been turned on, press the Power  button to take a photo. A short vibration and a flash of Green LED indicate the action was successful.



- !! The still photo function is disabled during video recording.
- !! The default photo mode is “single photo”. Burst mode gives you a continuous 10 photo shots to capture that “can’t miss” moment. Time Lapse mode can be utilized to take a series of photos at 5, 10, 30 or 60-second intervals. To change the mode, please refer to the section “Changing the camera settings”
- !! If the card is full, the camera will vibrate for five seconds and the Green LED will flash continuously.



Reset the Camera

Press the Reset button with a thin and blunt object to reset the camera.

Using PODZ

PODZ is a series of accessories that work with your camera and provide additional functions and enhance your excitement. Insert the PODZ into the PODZ socket of the camera and you can use it immediately.

PODZ – Basic back cover to seal your camera

WiFi PODZ – Provide the wireless capability to your camera

Remote PODZ – Control your camera via the remote

Battery PODZ – Extended battery time of your camera.

Using CamLOCK Mount System

ion's versatile CamLOCK Mount System allows you to attach the AIR PRO camera to any type of helmet (bike, motorcycle, ski, skydive etc.), pole, board (surf, skate, ski etc.) and handlebar (bike and motorcycle).

Please refer to the specific mounting guides for instructions on how to install your mounts with your camera for particular activities.

Visit the ion website (www.iontheaction.com) to get the latest news regarding PODZ and CamLOCK products.

Auto Rotation

The camera has a built-in G-sensor which is able to detect the camera orientation. By rotating your camera to 90°, 180° or 270° from the default position (refer to the picture), the recorded view will be rotated in the same angle. This allows the user to mount the camera in different orientation without recording a rotated or inverted view. The video resolution will be adjusted for 90° and 270°.



Video Resolution	0° or 180°	90° or 270°
1080P	1920x1080	608x1088
960P	1280x960	720x960
720P	1280x720	416x720



- !! The feature is available only for videos capturing, not still photos.
- !! Adjust your camera orientation before you start the video recording. The rotation feature will not be activated throughout the recording.
- !! You can disable the auto rotation function in the “General settings” with the ion software



CONNECTING CAMERA TO A COMPUTER

Running the ion Software

1. Insert a MicroSD card with at least 2MB free space into your camera.
2. Connect your camera to a PC via the USB cable included.
3. Press the Power  button to turn the camera
4. Open the MicroSD card folder inside file manager and you will find the file “ion.exe”. Click the file to open
5. If you cannot find ion.exe at your MicroSD folder, you can unplug the cable from PC and turn the camera on and off once and connect the PC again.



!! If you are a Mac user, visit the ion website (www.iontheaction.com) to download the software in Mac version.

Browsing the Files & Transferring Them To A PC

1. Click the “Browse Files” icon and the file folder will pop up and the saved photo and video files will be displayed on the browser.
2. Double click a photo or video file to preview the content.
3. Copy or Move the files to your PC hard drive to store them on your computer or share them with social media websites or via email.



!! The FHD/HD video files will be saved as, e.g. IONX0001.mp4. The 432x240 or 320x240 video recorded at the same time will be saved as IONX0001_thm.mp4.

Changing the Camera Settings

The ion AIR PRO's camera settings can be changed by utilizing the ion software.

Simply click on the options in the Photo, Video or General menus.

Set up on Photo menu

Click "Photo" menu to select the desired photo resolution and mode. The active mode will be highlighted.



<u>Mode</u>	<u>Options</u>
Photo Resolution	16MP(Software Enhanced), 5MP, 3MP, VGA
Photo Mode	Single Shot, Burst, Time Lapse
Time Lapse	5, 10, 30, 60 seconds



Set up on Video menu

Click the “Video” menu to select the desired video resolution. The active mode will be highlighted.



<u>Mode</u>	<u>Options</u>
FHD Resolution	1080p: 1920x1080 pixels (16:9), 30 fps (default) 960p: 1280x960 pixels (4:3), 30 fps
HD Resolution	720p: 1280x720 pixels (16:9), 60 fps (default) 720p: 1280x720 pixels (16:9), 30 fps

For setting up the General menu

Click “General” menu to select various general settings for the camera. The active mode will be highlighted.

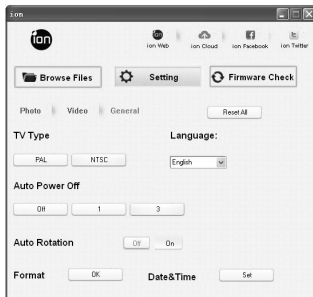

<u>Mode</u>	<u>Option</u>
TV Type	PAL, NTSC
Language	English, Italian, German, Spanish, French, Japanese, Korean, Chinese (Simplified and Traditional)
Auto Power Off	Off, 1, 3 Minutes
Auto Rotation	On, Off
Date & Time	Date, Time, Sync with PC
Format	Ok

To reset the camera to the default settings

Clicking “Reset All” will return to default settings.



Linking to ion Websites and Cloud Service

You can access more ion information by clicking the icons at the top



ion Official Website



ion Cloud Website



ion Facebook

ion Facebook Page



ion Twitter

ion Twitter Page

Firmware Update and Installation

In order to keep your ion camera performing at its best, regularly check for new firmware updates and install them to your camera. Before you update the firmware, make sure you connect your camera to an internet accessible computer.

To perform a firmware check and update

1. Before doing a firmware check or update, put the MicroSD which has at least 15MB free space in the camera.
2. Click the "Firmware Check" button.
3. Click the "Check" button.
4. The ion software will automatically determine if there is a new firmware version available. A notification will be given if a new firmware version has been detected, display the new version number and indicate the new version numbers and enhancements for the new version.
5. Click "Download" button and the new firmware version will be downloaded to

the MicroSD card. A notification will be given indicating that the download has successfully transferred to the card.

6. Click the "Install" button to confirm that you want to install the newer firmware version.
7. Unplug the USB cable from the PC and the camera will automatically install the latest firmware version. The Green LED illuminates to show that the firmware is installing. The process will take approximately 20 seconds.
8. The Green LED will turn off once the installation of the new firmware is completed.
9. The camera will turn off when the upgrade is done. You can power on the camera and the new firmware will be effective.



- !! Place your camera in a stable position during the full firmware update process**
- !! Assure you don't reset or remove the MicroSD card before the full update process has been completed. The interruption will lead to potential damage to the camera**
- !! Any abnormal conditions such as the sudden interruption of the power supply will cause the camera to potentially be damaged due to the firmware update interruption.**





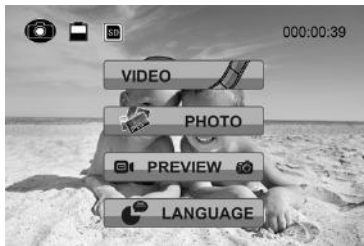

CONNECTING CAMERA TO A TV / HDTV

Connect your ion camera to a TV or HDTV thru the AV cable or an HDMI cable (not included). When you have successfully connected, the TV menu as shown in the picture below will pop up. You can preview files, playback, delete files and format the MicroSD card thru your TV screen.







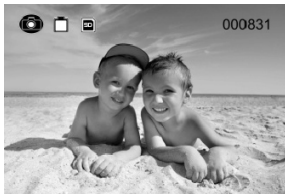

- !! In order to turn off the AIR PRO camera, you will first need to disconnect the camera from the TV/HDTV
- !! Assure there is a MicroSD card in the camera or no card will be displayed on the TV screen.
- !! No files will be displayed on the TV screen if you don't have any files in the MicroSD card.

Taking Photos w/ TV

1. Press and hold the Power  button until the TV menu appears.
2. Press the Power  button shortly to select the Preview mode.
3. Slide the Recording Slide Switch  to STOP
4. Press the Power  button twice to enter Photo Preview mode.
5. Press the Power  button to take photos.







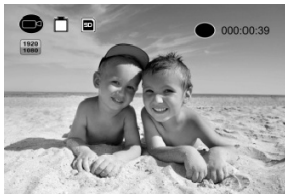



Recording Video w/ TV

1. Press and hold the Power  button until the TV menu appears.
2. Press the Power  button shortly to select the Preview mode.
3. Slide the Recording Slide Switch  to REC
4. Press the Power  button twice to enter Video Preview mode.
5. Press the Power  button to start recording, and press it again to stop recording videos, or slide the Recording Slide Switch  to STOP to stop recording and enter to the Photo mode









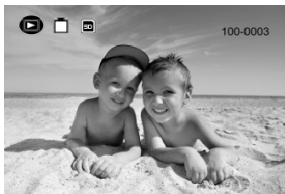



!! You can use  to change between Video and Photo Preview mode.

Playing Back Photo Files w/ TV

1. Press and hold  button until the TV menu appears.
2. Press  button shortly to select the Play Photo mode.
3. Press  button twice to enter the Play Photo mode.
4. Select the desired photo file you want to view:
 - a) Slide  to REC and press  button shortly to the previous file;
 - b) Slide  to STOP and press  button shortly to the next file.
5. Press  button twice to start the slide show and press it again to stop.
6. Press and hold  button to enter to Edit menu.



Playing Back Video Files w/ TV



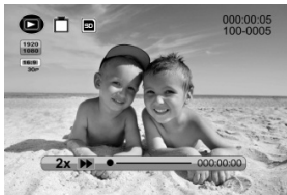

1. Press and hold  button until the TV menu appears.
2. Press  button shortly to select the Play Video mode.
3. Press  button twice to enter the Play Video mode.
4. Select the desired video file you want to view:
 - a) Slide  to REC and press  button shortly to the previous file;
 - b) Slide  to STOP and press  button shortly to the next file.
5. Press  button twice to start playing the video
6. When the video is playing, press  button shortly one time to pause and press  button twice again to continue.
7. Press and hold  button to enter to Edit menu.



Change TV Language

There are 9 different languages for you to select.

To change the setting

1. Press and hold  button until the TV menu appears.
2. Press  button shortly to select Language mode.
3. Press  button twice to enter the language setting mode.
4. Press  button shortly to select the desired language.













5. Press  button twice to enter TV menu and the language will be changed

Deleting Photos / Video Files w/ TV







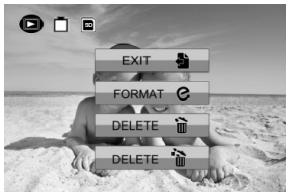

You can delete a single and all photo or video file(s) in the MicroSD card.

To delete the files

1. Press and hold  button until the TV menu appears.
2. Press  button shortly to select Play Photo or Video mode.
3. Press  button twice to enter the Photo or Video Playback mode.
4. Select the desired photo or video file to be deleted.
5. Press and hold  button to enter to Edit menu.
6. Press the  button shortly to select "Delete This Image/Video" or "All".
7. Press the  button twice to enter to "Delete This Image/Video" or "All".
8. Press  button shortly to select "Yes".
9. Press  button twice to confirm.



Formatting MicroSD Card w/ TV

1. Press and hold  button until the TV menu appears.
2. Press  button shortly to select Play Photo or Video mode
3. Press  button twice to enter either the Photo or Video Playback mode.
4. Press and hold  button to enter to Edit menu.
5. Press  button shortly to select "Format"
6. Press  button twice to enter "Format" interface
7. Press  button shortly to select "YES" and press  button twice to confirm formatting. The MicroSD will be formatted.

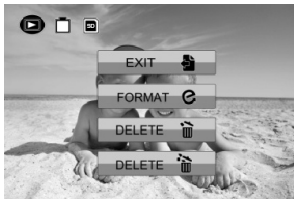



SIGN UP FOR FREE ION CLOUD STORAGE

8GB of free Cloud storage will be provided for storing and sharing of video and photo content. You can visit www.iontheaction.com/ioncloud and sign up as a free member.



HOME PRODUCTS SUPPORT NEWS CLOUD HISTORY PRESS & PR REGISTER



shoot/share™ and enjoy your iON Air Pro action photos and videos from anywhere!

Get it FREE →



Upload photos and videos without connecting to a PC



Access Photos & Videos from Any Device



Share on Facebook, Twitter and more...



Secure Personal Cloud Storage

SPECIFICATION

Sensor	5 Mega Pixels CMOS sensor
Lens	170° ultra wide angle field of view
Focus range	0.5m - ∞
Video	1080p: 1920x1080 pixels (16:9), 30 fps
	960p: 1280x960 pixels (4:3), 30 fps
	720p: 1280x720 pixels (16:9), 60 fps
	720p *: 1280x720 pixels (16:9), 30 fps
	Format: H.264 compression, saved as MPEG4 (.mp4) file Dual video files for easy sharing
Photo	Resolution: 5 Mega Pixels in JPEG format
	Capture Modes: Single, Burst*, Time lapse*
Audio	Built-in high quality microphone
	AAC Compression, Automatic Gain Control
Storage	MicroSD/MicroSDHC in min class 6 up to 32GB
	Average Recording Times: about 4 hours (using 32GB mSD card in 1080p30/720p60)
Connection	USB2.0 (for data connection and battery charging)
	HDMI
	AV / Composite
Power	Build-in 1200 mAH Rechargeable Li-Polymer Battery
	Battery Life: Approx. 2.5 hrs / 1 hr (w/ WiFi PODZ)
Housing	High quality Aluminum barrel and rubberized finishing
	Depth up to 10 meters / 30 feet
Dimension	40 x 40 x 108 mm
Weight	~130g or 4.58oz

* Settings can be changed through PC connection



SYSTEM REQUIREMENTS

Operating system	Windows® 7/XP SP3 /Vista and Mac 10.5 or above
CPU	Pentium III or above
RAM	At least 64MB
Interface	USB port
CD	4x speed CD ROM or above

TROUBLESHOOTINGS

Problems	Causes	Solutions
1. LED flashes and camera turns off 2. Cannot turn on the ion camera	Run out of battery	Recharge the camera
Red LED flashes during recording	Low battery	Recharge the camera
Cannot take photos or video (Green LED flashes)	Memory full	Replace with a memory card with space available for contents
Cannot take photos or video (Green and Red LED flashes alternatively)	1. MicroSD card is not inserted 2. MicroSD card has not been formatted properly.	1. Insert a MicroSD card 2. Format the MicroSD card at PC
Cannot find removable disk after connecting the camera to the computer.	Connection failure.	1. Make sure all cable connections are secured and restart the computer if necessary 2. Try a different USB port on the computer